

Data Sheet

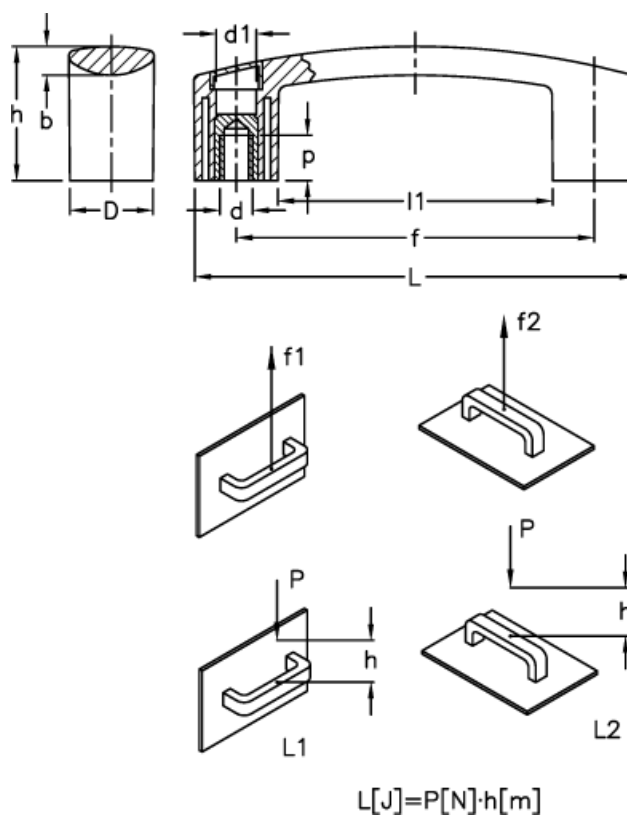

Article number: 23052601216
Description: E+G Bridge handle
EBP.110-B M6-C6

Measures



b	= 7.5	L	= 116.0
D	= 22.0	l1	= 72.0
d1	= 10.5	L1 (J)	= 8
d 6H	= M6	L2 (J)	= 3
f	= 93,5 +/-0,5	p	= 12
F1 (N)	= 2000		
F2 (N)	= 1500		
h	= 35		